

Fitting the brackets

1

The brackets offer two methods of installation:

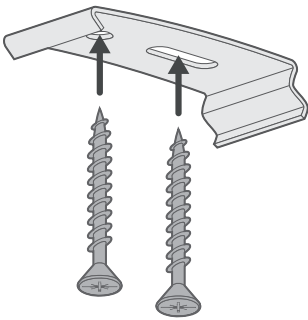

Top-Fixing

Where the brackets are screwed into the lintel (or 'ceiling' of the recess)

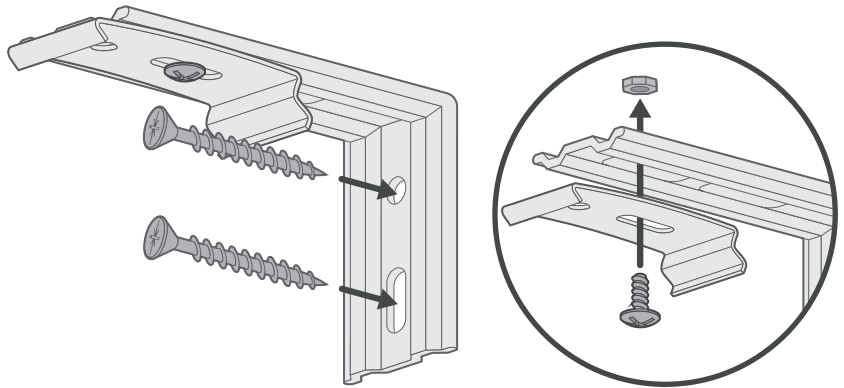

Face-Fixing

Where the brackets are screwed onto a facing surface (a wall or window frame)

Joining the tracks

2

If your track is less than 2900mm wide, skip to step 3.

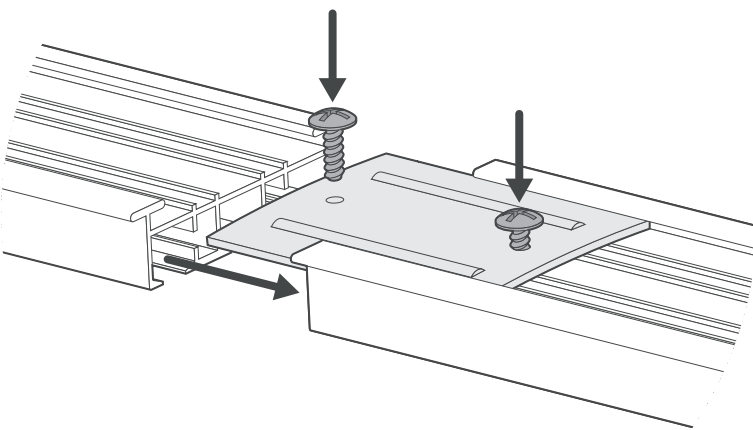

If your width is greater than 2900mm, you will be provided with 2 tracks and a joining plate to connect them together.

Slot the joining plate into the channel at the top of one part of the rail, then slot the other part of the rail into place beside it, ensuring that the joining plate is central. Then insert the provided screws into the holes in the fixing plate and screw in tightly to secure the rails together.

Fitting the track

3

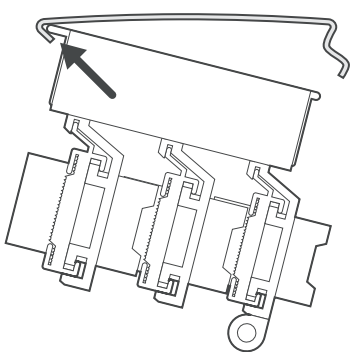

Rest the front lip of the headrail in the front lip of the bracket.

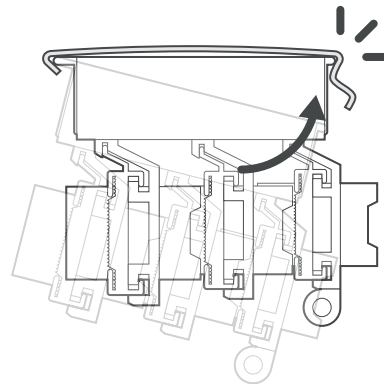

Then twist the back of the headrail upwards until it snaps into place in the rear hook of the bracket.

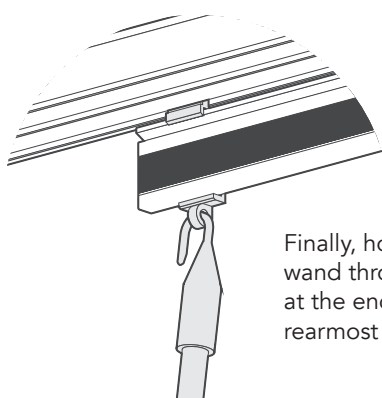

Finally, hook the control wand through the eyelet at the end of the rearmost glider.

For wider tracks with more panels, hook the front hook of the bracket over the centre lip of the headrail, rather than the front lip.

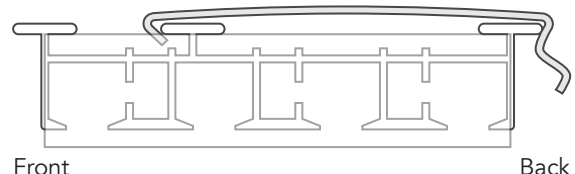

Attaching the fabric

4

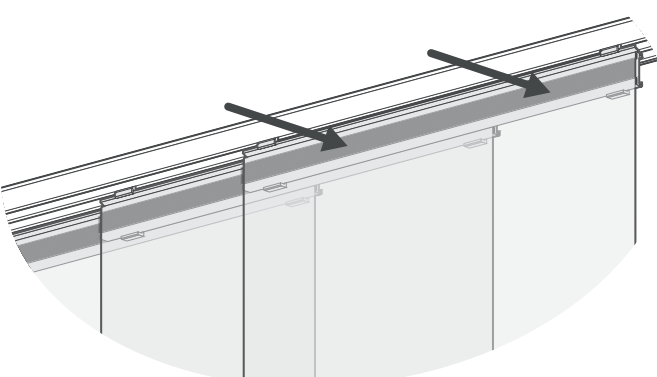

Simply press the Velcro strip on the back of each panel onto the corresponding strip of each glider.