

Before you begin

The front roller blind is the highest and closest to you, so make sure that when marking the place where you will place the brackets, the rounded part of the bracket is pointing downwards.

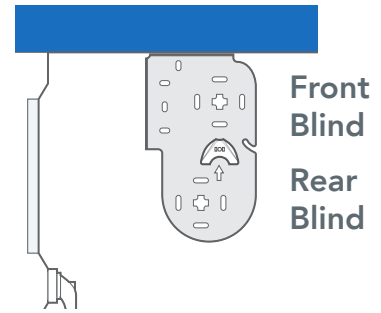

Fitting the brackets

1

The brackets offer three methods of installation:

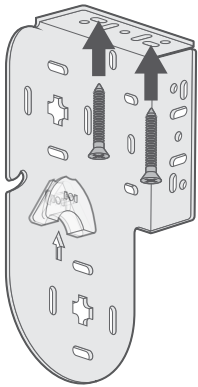

Top-Fixing

Where the brackets are screwed into the lintel (or 'ceiling' of the recess)

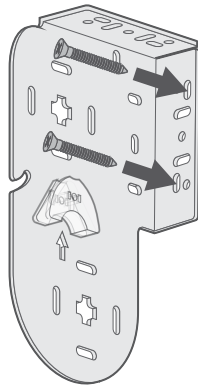

Face-Fixing

Where the brackets screw into a facing surface (a wall or window frame)

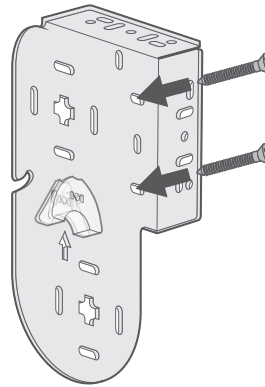

Side-Fixing

Where the brackets are screwed into the side walls of the recess

Top Tip

Top-fixing or face-fixing are recommended for most installations, whereas **side-fixing is only recommended if the width you gave us was taken right at the top of the recess.**

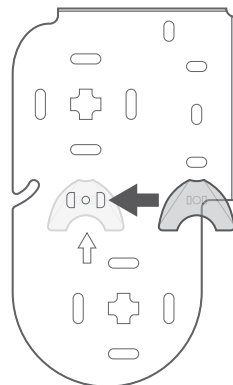

Control Side

On the control side, clip the chain runner attachment into the slot in the center of the bracket.

Fitting the blind

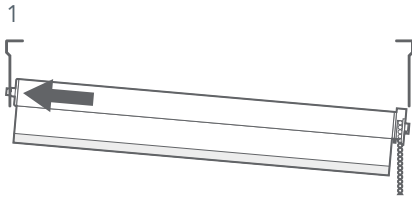

Install the rear blind first. Begin by placing the spring-loaded pin into the lower cross-shaped hole on the bracket. Push the blind toward the bracket so the spring-loaded pin depresses.



Keeping the pin depressed, lift the sidewinder end of the blind upwards so the blind is level and the chain is hanging directly down from the bottom of the sidewinder and slot the pegs of the control into the cross section of the bracket.

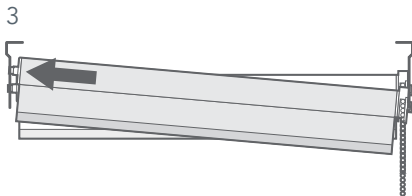

Repeat the process for the front blind placing the pin into the cross-shaped hole on the bracket and lifting the sidewinder side up to slot into the cross section.

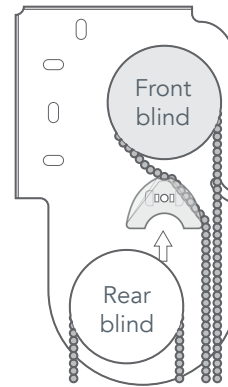
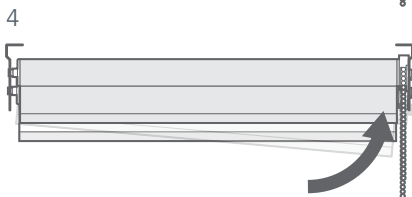

Take the chain for the top (front) blind and drape the back part of the chain over the chain runner so that the chain sits forward, preventing it from tangling with the other blind's chain.

If you upgraded to our Twist2Fit system

Starting with the sheer blind, insert the blind into the recess at an angle and push the tightener against the wall.



Lift the control end of the blind until level and release pressure, the blind will hold itself in place.

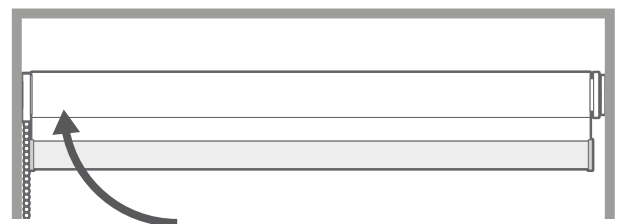

Make adjustments to the position of the blind so that it is straight and level, before locking it in place.

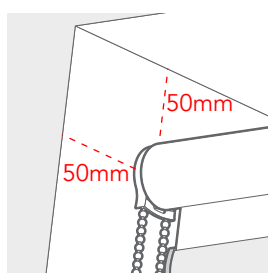

We recommend fitting the rear blind approximately 50mm down from the top of the recess, and 50mm in from the front of the recess.

For smaller blinds:

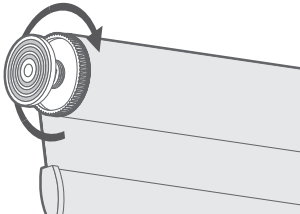

Tightener on the left

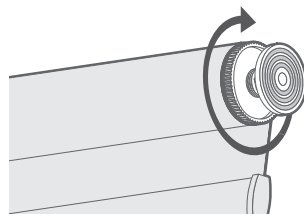

Tightener on the right

Hold the blind securely in place and turn the tightening wheel to tighten the blind in place.

If the tightener is on the left side of the blind turn it towards you. If it's on the right, turn it away from you.

Top Tip

Make sure that you tighten the wheel as much as you possibly can so that the blind remains secure and does not slip. If you find that the 'foot' of the mechanism that presses against the wall is spinning as you try to tighten, take the blind out of the window, tighten it a little, then push it back into place and try again.

For larger blinds:

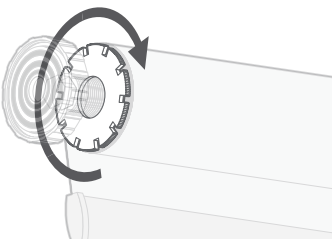

Tightener on the left

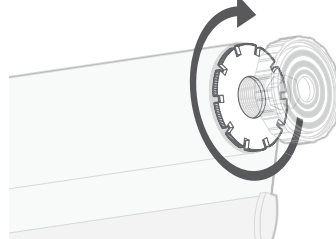

Tightener on the right

Hold the blind securely in place and turn the tightening wheel to tighten the blind in place.

If the tightener is on the left side of the blind turn it towards you. If it's on the right, turn it away from you.

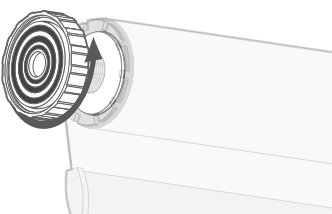

cap on the left

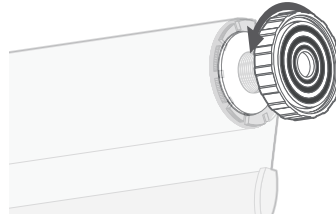

Cap on the right

Once the blind is secured in place, turn the end cap until it locks against the tightening wheel. This will lock the tightening wheel in place.

If the cap is on the left side of the blind turn it away from you. If it's on the right, turn it towards you.

Next, fit the blackout blind at the front. The process is exactly the same as for the rear blind.

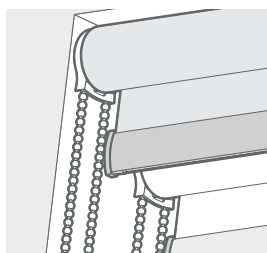
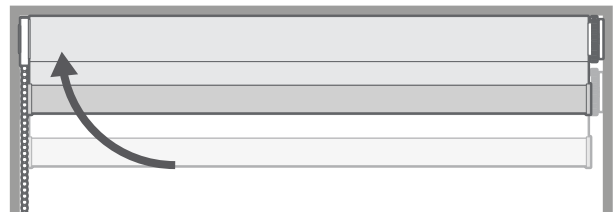
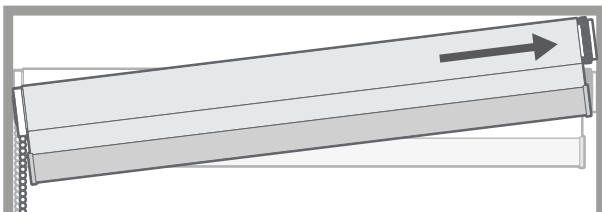

The front blind can be fitted at the top and front of the recess. If you'd prefer to have the blinds further back in the recess then that's fine, just make sure that the front blind is fitted roughly 50mm in front of the rear blind.

Child Safety

4

Fitting the cord tensioner

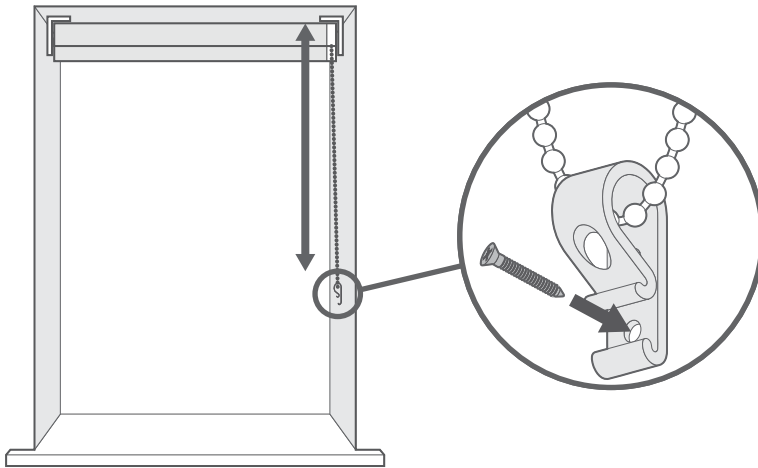

The cord retaining device must be installed at the maximum distance possible from the control mechanism to prevent looped cords from becoming slack.

Place the retaining device on the wall (one for each chain) and mark the position of the screw hole(s) with a pencil.

Attach the retaining device to the wall using the fixings provided.